

CHEVROLET



2023
TRAILBLAZER

Experience everything.

There's a big world waiting to be explored, and the 2023 Trailblazer is the small SUV that's ready, willing and able to be your guide.

Available in FWD or AWD, Trailblazer can carry you to adventures on city streets or unpaved paths. No matter where your travels take you, rugged looks will get you noticed and a flexible, functional interior will provide room for all your gear. Plus, standard Chevy Safety Assist¹ with six advanced driver assistance features provides peace of mind wherever you roam.

When you want to discover something new, Trailblazer is up for anything.



Trailblazer ACTIV in Nitro Yellow Metallic (extra-cost color) with Summit White roof and available features.

¹ Chevy Safety Assist includes Automatic Emergency Braking, Front Pedestrian Braking, Lane Keep Assist with Lane Departure Warning, Forward Collision Alert, IntelliBeam and Following Distance Indicator. Safety or driver assistance features are no substitute for the driver's responsibility to operate the vehicle in a safe manner. Read the vehicle Owner's Manual for important feature limitations and information.

At a glance.

- Five-passenger small SUV with four models to choose from: LS, LT, ACTIV and RS
- All models available as FWD or AWD
- Three available drive modes¹
- ACTIV developed and tuned for off-road use
- Chevy Safety Assist², standard on all models, includes
 - Automatic Emergency Braking
 - Front Pedestrian Braking
 - Lane Keep Assist with Lane Departure Warning
 - Forward Collision Alert
 - IntelliBeam[®]
 - Following Distance Indicator
- A generous 39.4 inches of rear-seat leg room
- Up to 54.4 cubic feet of maximum cargo space³ with the rear seats folded flat
- Maximum cargo length is 8.5 feet with the front passenger seat and rear seats folded flat – so you can fit longer items like kayaks or ladders
- The flexible cargo area features a reversible two-tier floor, with one side carpeted and the other side a durable surface for easy cleaning



Trailblazer can accommodate items up to 8.5 feet long.



Trailblazer ACTIV interior in Jet Black with Arizona accents and available features.

¹ Requires available ECOTEC 1.3L Turbo engine. ² Safety or driver assistance features are no substitute for the driver's responsibility to operate the vehicle in a safe manner. Read the vehicle Owner's Manual for important feature limitations and information. ³ Cargo and load capacity limited by weight and distribution.

Four models to choose from.



LS

When you want style and need substance in your small SUV, LS is where you start.

- ECOTEC® 1.2L Turbo engine (FWD models)
- ECOTEC 1.3L Turbo engine with Driver Mode Selector (AWD models)
- 17-inch Silver-painted aluminum wheels
- Jet Black cloth interior
- Fold-flat front passenger seatback
- Wireless Apple CarPlay®¹ compatibility
- Wireless Android Auto™² compatibility
- Chevrolet Infotainment 3 system³ with 7-inch diagonal color touch-screen
- 6-speaker audio system
- Single-zone automatic air conditioning
- Chevy Safety Assist⁴



LT

Comfort and convenience features take Trailblazer LT to a whole new level.

- Silver-painted front and rear fascias and roof rails
- LED fog lamps
- 17-inch high-gloss Black machined-aluminum wheels
- Deep-tinted rear windows and liftgate glass
- Heated power-adjustable mirrors with body-color caps
- Heated front seats
- Remote vehicle starter system
- Keyless Open and Start
- Electronic cruise control
- 8-way power driver seat with 2-way power lumbar control



ACTIV

ACTIV is the one that feels most at home when you take it off-road.

- ECOTEC 1.3L Turbo engine
- Special shocks and sport terrain tires
- Functional skid plate
- 17-inch high-gloss Black machined-aluminum wheels
- Available contrasting roof color
- Black roof rails
- Dual-outlet exhaust with trapezoidal polished tips
- Heated power-adjustable mirrors with roof-color caps
- Titanium chrome-plated front and rear fascias and bold side cladding
- Leatherette seating surfaces
- Heated leather-wrapped steering wheel and leather-wrapped shift knob



RS

Sleek and sporty, RS was designed to stand out from the crowd.

- Camaro-inspired front grille
- 18-inch high-gloss Black machined-aluminum wheels
- Available contrasting roof color
- Black roof rails
- Dual-outlet exhaust with round polished tips
- Black Chevrolet bowtie emblems
- Heated power-adjustable mirrors with gloss Black caps
- Sporty Jet Black cloth and leatherette seating surfaces with Red accents
- Heated leather-wrapped flat-bottom steering wheel
- Leather-wrapped shift knob with RS logo

¹ Vehicle user interface is a product of Apple and its terms and privacy statements apply. Requires compatible iPhone and data plan rates apply. ² Vehicle user interface is a product of Google and its terms and privacy statements apply. To use Android Auto on your car display, you'll need an Android phone running Android 6 or higher, an active data plan, and the Android Auto app. ³ Chevrolet Infotainment System functionality varies by model. Full functionality requires compatible Bluetooth and smartphone, and USB connectivity for some devices. ⁴ Chevy Safety Assist includes Automatic Emergency Braking, Front Pedestrian Braking, Lane Keep Assist with Lane Departure Warning, Forward Collision Alert, IntelliBeam and Following Distance Indicator. Safety or driver assistance features are no substitute for the driver's responsibility to operate the vehicle in a safe manner. Read the vehicle Owner's Manual for important feature limitations and information.

Apple CarPlay, iPhone, Siri and Apple Music are trademarks of Apple Inc., registered in the U.S. and other countries. Google, Android and Android Auto are trademarks of Google LLC.

Due to current supply chain shortages, certain features shown have limited or late availability, or are no longer available. See the window label or a dealer regarding the features on an individual vehicle.

LS



Summit White



Sterling Gray Metallic



Crimson Metallic



Mahogany Red Metallic



Blue Glow Metallic



Mosaic Black Metallic

LS



Select standard features:

MECHANICAL

Driver Mode Selector (AWD models)

Engine – ECOTEC 1.2L Turbo with Variable Valve Timing (VVT), Direct Injection and Automatic Stop/Start with override (FWD models)
– ECOTEC 1.3L Turbo with Variable Valve Timing (VVT), Direct Injection and Automatic Stop/Start with override (AWD models)

Transmission – Continuously Variable Transmission (CVT) with Driver Shift Control (FWD models)
– 9-speed automatic with Driver Shift Control (AWD models)

EXTERIOR

Headlamps – halogen, automatic on/off with automatic delay

Mirrors – power-adjustable, manual-folding with Black caps

Tires – P225/60R17 all-season

Wipers – front variable-speed, intermittent with washers; rear intermittent with washer

INTERIOR

Air conditioning – electronic, single-zone

Door locks – power programmable with lockout protection and manual rear door child security

Entertainment – Chevrolet Infotainment 3 system¹ with 7-inch diagonal color touch-screen

Media – USB ports²; one Type-A and one Type-C, and auxiliary input jack in front center stack storage area

Seat – driver 6-way manual adjuster
– front passenger flat-folding seatback
– rear manual-folding 40/60 split-bench

SiriusXM^{®3} – 3-month trial subscription to SXM Platinum Plan

Steering column – manual tilt and telescopic

Steering wheel – 3-spoke with mounted audio, phone and Driver Information Center controls

Windows – power with driver express-up/-down, all others express-down

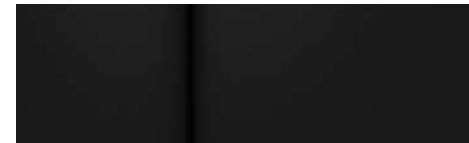

Jet Black Cloth



17" Silver-Painted Aluminum Wheels (Q6W)
Standard on LS

¹ Chevrolet Infotainment System functionality varies by model. Full functionality requires compatible Bluetooth and smartphone, and USB connectivity for some devices. ² Not compatible with all devices. ³ If you decide to continue service after your trial, your selected subscription plan will automatically renew thereafter. You will be charged at then-current rates. Fees and taxes apply. To cancel you must call SiriusXM at 1-866-635-2349. See SiriusXM Customer Agreement for complete terms at siriusxm.com. All fees and programming subject to change.

LT



Summit White



Iridescent Pearl Tricoat¹



Sterling Gray Metallic



Crimson Metallic



Mahogany Red Metallic



Vivid Orange Metallic¹



Blue Glow Metallic



Mosaic Black Metallic

¹Extra-cost color.

LT



Select standard features:

MECHANICAL

Driver Mode Selector (AWD models)

Engine – ECOTEC 1.2L Turbo with Variable Valve Timing (VVT), Direct Injection and Automatic Stop/Start with override (FWD models)
– ECOTEC 1.3L Turbo with Variable Valve Timing (VVT), Direct Injection and Automatic Stop/Start with override (AWD models)

Transmission – Continuously Variable Transmission (CVT) with Driver Shift Control (FWD models)
– 9-speed automatic with Driver Shift Control (AWD models)

EXTERIOR

Fascia – front and rear lower, Silver-painted

Fog lamps – LED

Glass – deep-tinted rear windows and liftgate

Mirrors – heated, power-adjustable, manual-folding with body-color caps

Roof rails – Silver-painted

INTERIOR

Cruise control – electronic with Set and Resume Speed

Entertainment – Chevrolet Infotainment 3 system¹ with 7-inch diagonal color touch-screen

Keyless Open and Start – includes extended-range Remote Keyless Entry

Remote vehicle starter system

Seat – driver 8-way power adjuster with 2-way power lumbar control

SiriusXM^{®2} – 3-month trial subscription to SXM Platinum Plan

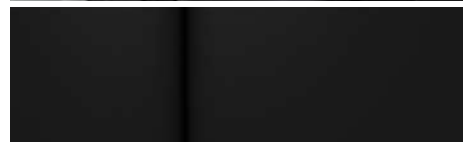
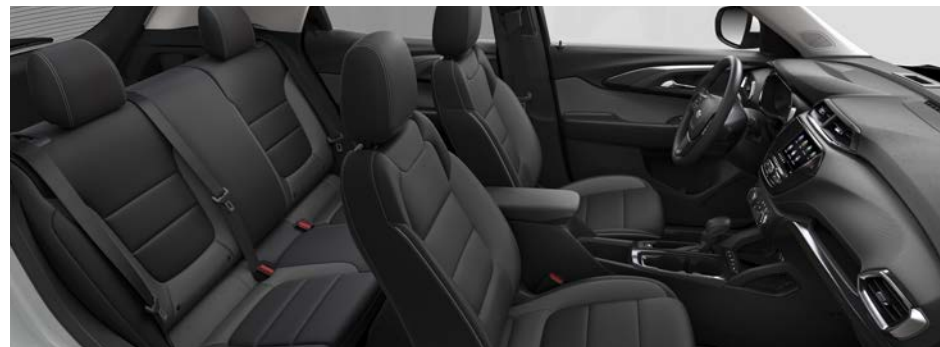

Jet Black Cloth



17" High-Gloss Black Machined-Aluminum Wheels (Q6V)
Standard on LT

¹ Chevrolet Infotainment System functionality varies by model. Full functionality requires compatible Bluetooth and smartphone, and USB connectivity for some devices. ² If you decide to continue service after your trial, your selected subscription plan will automatically renew thereafter. You will be charged at then-current rates. Fees and taxes apply. To cancel you must call SiriusXM at 1-866-635-2349. See SiriusXM Customer Agreement for complete terms at siriusxm.com. All fees and programming subject to change.

Some features shown may have limited, late or no availability. See dealer for feature availability.

ACTIV



Summit White



Sterling Gray Metallic/Summit White



Nitro Yellow Metallic/Summit White



Vivid Orange Metallic¹/Summit White



Blue Glow Metallic/Summit White



Mosaic Black Metallic/Summit White



Iridescent Pearl Tricoat¹

¹Extra-cost color.

ACTIV



Select standard features:

MECHANICAL

Driver Mode Selector

Engine – ECOTEC 1.3L Turbo with Variable Valve Timing (VVT), Direct Injection and Automatic Stop/Start with override

Exhaust – dual-outlet with trapezoidal polished tips

Skid plate – functional

Suspension – off-road tuning

Transmission – Continuously Variable Transmission (CVT) with Driver Shift Control (FWD models)
– 9-speed automatic with Driver Shift Control (AWD models)

EXTERIOR

Fascia – front and rear lower, titanium chrome-plated

Fog lamps – LED

Glass – deep-tinted rear windows and liftgate

Mirrors – heated, power-adjustable, manual-folding with roof-color caps

Roof rails – Black

Tires – P225/60R17 sport terrain

INTERIOR

Cruise control – electronic with Set and Resume Speed

Entertainment – Chevrolet Infotainment 3 system¹ with 7-inch diagonal color touch-screen

Keyless Open and Start – includes extended-range Remote Keyless Entry

Remote vehicle starter system

Seat – driver 8-way power adjuster with 2-way power lumbar control

SiriusXM^{®2} – 3-month trial subscription to SXM Platinum Plan

Steering wheel – 3-spoke, leather-wrapped

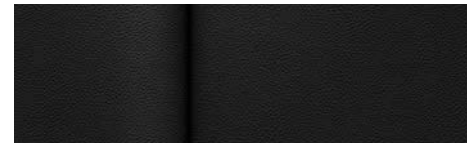

Jet Black Leatherette Seating Surfaces with Arizona Accents



17" High-Gloss Black Machined-Aluminum Wheels (MZD)
Standard on ACTIV

¹ Chevrolet Infotainment System functionality varies by model. Full functionality requires compatible Bluetooth and smartphone, and USB connectivity for some devices. ² If you decide to continue service after your trial, your selected subscription plan will automatically renew thereafter. You will be charged at then-current rates. Fees and taxes apply. To cancel you must call SiriusXM at 1-866-635-2349. See SiriusXM Customer Agreement for complete terms at siriusxm.com. All fees and programming subject to change.

RS



Summit White/Mosaic Black Metallic



Iridescent Pearl Tricoat¹/Mosaic Black Metallic



Sterling Gray Metallic/Mosaic Black Metallic



Nitro Yellow Metallic¹/Mosaic Black Metallic



Crimson Metallic/Mosaic Black Metallic



Fountain Blue¹/Mosaic Black Metallic



Mosaic Black Metallic



Sterling Gray Metallic/Crimson Metallic



Mosaic Black Metallic/Crimson Metallic

¹Extra-cost color.

RS



Select standard features:

MECHANICAL

Driver Mode Selector

Engine – ECOTEC 1.3L Turbo with Variable Valve Timing (VVT), Direct Injection and Automatic Stop/Start with override

Exhaust – dual-outlet with round polished tips

Transmission – Continuously Variable Transmission (CVT) with Driver Shift Control (FWD models)
– 9-speed automatic with Driver Shift Control (AWD models)

EXTERIOR

Chevrolet bowtie emblems – Black

Fascia – front and rear, Black

Fog lamps – LED

Glass – deep-tinted rear windows and liftgate

Mirrors – heated, power-adjustable, manual-folding with gloss Black caps

Roof rails – Black

Tires – P225/55R18 all-season

INTERIOR

Cruise control – electronic with Set and Resume Speed

Entertainment – Chevrolet Infotainment 3 system¹ with 7-inch diagonal color touch-screen

Keyless Open and Start – includes extended-range Remote Keyless Entry

Remote vehicle starter system

Seat – driver 8-way power adjuster with 2-way power lumbar control

SiriusXM^{®2} – 3-month trial subscription to SXM Platinum Plan

Steering wheel – flat-bottom, leather-wrapped

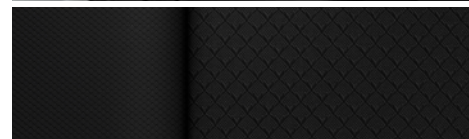
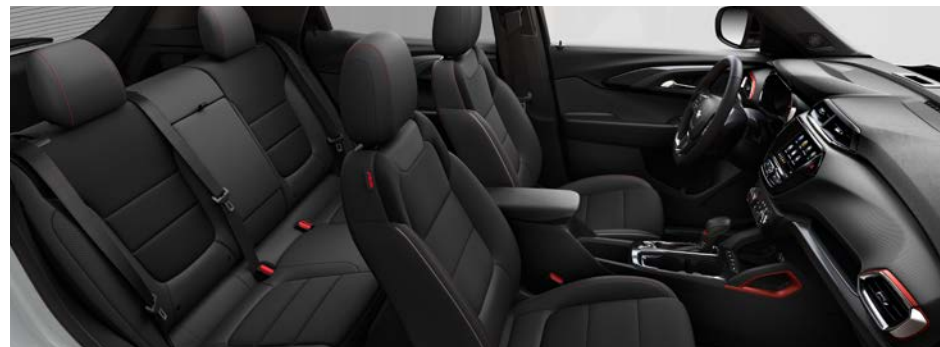

Jet Black Cloth/Leatherette Seating Surfaces with Red Accents



18" High-Gloss Black Machined-Aluminum Wheels (PZW)
Standard on RS

¹ Chevrolet Infotainment System functionality varies by model. Full functionality requires compatible Bluetooth and smartphone, and USB connectivity for some devices. ² If you decide to continue service after your trial, your selected subscription plan will automatically renew thereafter. You will be charged at then-current rates. Fees and taxes apply. To cancel you must call SiriusXM at 1-866-635-2349. See SiriusXM Customer Agreement for complete terms at siriusxm.com. All fees and programming subject to change.

Some features shown may have limited, late or no availability. See dealer for feature availability.

● STANDARD ○ AVAILABLE – NOT AVAILABLE

	LS	LT	ACTIV	RS
SAFETY AND DRIVER ASSISTANCE				
Chevy Safety Assist¹	●	●	●	●
Automatic Emergency Braking	●	●	●	●
Front Pedestrian Braking	●	●	●	●
Lane Keep Assist with Lane Departure Warning	●	●	●	●
Forward Collision Alert	●	●	●	●
IntelliBeam, auto high beams	●	●	●	●
Following Distance Indicator	●	●	●	●
Airbags² – frontal and knee airbags for driver and front passenger; seat-mounted side-impact airbags and head-curtain airbags for front and rear outboard seating positions; includes Passenger Sensing System for passenger-side frontal and knee airbags	●	●	●	●
Lane Change Alert with Side Blind Zone Alert¹ (requires available Driver Confidence and Cruise Package on LS; requires available Driver Confidence Package on LT, ACTIV and RS)	○	○	○	○
LATCH system (Lower Anchors and Tethers for Children) – for child restraint systems	●	●	●	●
Rear Cross Traffic Alert¹ (requires available Driver Confidence and Cruise Package on LS; requires available Driver Confidence Package on LT, ACTIV and RS)	○	○	○	○
Rear Park Assist¹ (requires available Driver Confidence and Cruise Package on LS; requires available Driver Confidence Package on LT, ACTIV and RS; feature will not function on certain models without dealer retrofit; see dealer or window label for details)	○	○	○	○
Rear Vision Camera¹	●	●	●	●
HD Rear Vision Camera¹ (requires available Technology Package)	–	–	○	○
Teen Driver technology¹	●	●	●	●
Theft-deterrent system – unauthorized entry	●	●	●	●
Tire Pressure Monitoring System – with Tire Fill Alert (does not monitor spare tire)	●	●	●	●
Up to 3 months of OnStar[®] Safety & Security coverage³	●	●	●	●

	LS	LT	ACTIV	RS
MECHANICAL				
Air filter – engine air filter monitor	●	●	●	●
Brakes – 4-wheel antilock, 4-wheel disc with Duralife [®] rotors; electronic parking brake	●	●	●	●
Drive – front-wheel drive (FWD)	●	●	●	●
– all-wheel drive (AWD)	○	○	○	○
Driver Mode Selector (requires available ECOTEC 1.3L Turbo engine on LS and LT)	○	○	●	●
Engine – ECOTEC 1.2L Turbo with Variable Valve Timing (VVT), Direct Injection and Automatic Stop/Start with override; 137 hp @ 5000 rpm, 162 lb.-ft. of torque @ 2500 rpm	●	●	–	–
– ECOTEC 1.3L Turbo with Variable Valve Timing (VVT), Direct Injection and Automatic Stop/Start with override; 155 hp @ 5600 rpm, 174 lb.-ft. of torque @ 1600 rpm (available on LT FWD; included on LS and LT AWD)	○	○	●	●
Exhaust – dual-outlet with trapezoidal polished tips	–	–	●	–
– dual-outlet with round polished tips	–	–	–	●
Skid plate – functional	–	–	●	–
StabiliTrak[®] – Electronic Stability Control System with Traction Control; includes Hill Start Assist	●	●	●	●
Steering – power, electric, rack-and-pinion	●	●	●	●
Suspension – front MacPherson strut	●	●	●	●
– rear compound crank	●	●	●	●
– rear Watts link (AWD models)	○	○	○	○
– off-road tuning	–	–	●	–
Trailer provisions (available on LS AWD; not available on LS FWD; requires available ECOTEC 1.3L Turbo engine on LT FWD; included on LT AWD)	○	○	●	●
Transmission – Continuously Variable Transmission (CVT) with Driver Shift Control (FWD models)	●	●	●	●
– 9-speed automatic, electronically controlled with overdrive and Driver Shift Control (AWD models)	○	○	○	○

¹ Safety or driver assistance features are no substitute for the driver's responsibility to operate the vehicle in a safe manner. Read the vehicle Owner's Manual for important feature limitations and information. ² A NOTE ON CHILD SAFETY: Always use seat belts and the correct child restraint for your child's age and size, even with airbags. Even in vehicles equipped with the Passenger Sensing System, children are safer when properly secured in a rear seat in the appropriate infant, child or booster seat. Never place a rear-facing infant restraint in the front seat of any vehicle equipped with an active frontal airbag. See your vehicle Owner's Manual and the child safety seat instructions for more safety information. ³ When you select a monthly plan within 15 days of activating your 1-month trial, you'll receive the next 2 months of the plan you select at no additional charge when you associate an approved payment method on file to your account and authorize recurring payments for your service plan. The amount and frequency of each recurring payment is based upon the service(s) and payment interval(s) you select from the options provided. After the trial expires, OnStar will automatically bill your payment method monthly at then-current standard monthly rates. Plans containing 4G LTE data will be billed every 30 days by AT&T. You may cancel at any time by pushing your blue OnStar button or calling 1-888-466-7827. May not be combined with other offers or retroactively applied. Offer subject to change.

● STANDARD ○ AVAILABLE – NOT AVAILABLE

	LS	LT	ACTIV	RS
EXTERIOR				
Active aero shutters – lower grille	●	●	●	●
Chevrolet bowtie emblems – Black	-	-	-	●
Daytime running lamps – LED	●	●	●	●
Fascia – front and rear lower, Black	●	-	-	●
– front and rear lower, Silver-painted	-	●	-	-
– front and rear lower, titanium chrome-plated	-	-	●	-
Fog lamps – LED	-	●	●	●
Fuel filler cap – locking	●	●	●	●
Glass – solar-absorbing	●	●	●	●
– deep-tinted rear windows and liftgate	-	●	●	●
Headlamps – halogen with automatic on/off	●	●	●	●
– LED (requires available Technology Package)	-	-	○	○
Liftgate – rear, manual	●	●	●	●
– power, programmable, hands-free with LED logo projection (requires available Convenience Package and Driver Confidence Package)	-	-	○	○
Mirrors – power-adjustable, manual-folding with Black caps	●	-	-	-
– heated, power-adjustable, manual-folding with body-color caps	-	●	-	-
– heated, power-adjustable, manual-folding with roof-color caps	-	-	●	-
– heated, power-adjustable, manual-folding with gloss Black caps	-	-	-	●
Roof, one-tone – Summit White (requires Summit White exterior color)	-	-	○	-
– Iridescent Pearl Tricoat (requires Iridescent Pearl Tricoat ¹ exterior color)	-	-	○	-
– Mosaic Black Metallic (requires Mosaic Black Metallic exterior color)	-	-	-	○
Roof, two-tone – Summit White (requires Sterling Gray Metallic, Nitro Yellow Metallic, Vivid Orange Metallic, Blue Glow Metallic or Mosaic Black Metallic exterior color)	-	-	○	-
– Mosaic Black Metallic (requires Summit White, Iridescent Pearl Tricoat ¹ , Sterling Gray Metallic, Nitro Yellow Metallic, Crimson Metallic or Fountain Blue exterior color)	-	-	-	○
– Crimson Metallic (requires Sterling Gray Metallic or Mosaic Black Metallic exterior color)	-	-	-	○
Roof rails – Silver-painted	-	●	-	-
– Black	-	-	●	●
Taillamps – halogen	●	●	-	-
– LED	-	-	●	●
Tires – 225/65R17 all-season	●	●	-	-
– 225/60R17 sport terrain	-	-	●	-
– 225/55R18 all-season (requires available 18" aluminum wheels [RT1] on LT)	-	○	-	●
– compact spare	●	●	●	●

	LS	LT	ACTIV	RS
EXTERIOR (CONTINUED)				
Wheels – 17" Silver-painted aluminum (Q6W)	●	-	-	-
– 17" high-gloss Black machined-aluminum (Q6V)	-	●	-	-
– 17" high-gloss Black machined-aluminum (MZD)	-	-	●	-
– 18" high-gloss Black machined-aluminum (PZW)	-	-	-	●
Wipers – front variable-speed, intermittent; rear intermittent with washer	●	●	●	●
INTERIOR				
Active Noise Cancellation (AWD models)	○	○	○	○
Air conditioning – electronic, single-zone	●	●	●	●
– automatic, single-zone with cabin humidity sensor (requires available Convenience Package and Driver Confidence Package)	-	○	○	○
Air filter – cabin	●	●	●	●
Armrest – rear-seat center (requires available Convenience Package and Driver Confidence Package on LT)	-	○	●	●
Assist handles – overhead, all outboard seating positions	●	●	●	●
Compass display – located in Driver Information Center	●	●	●	●
Cruise control – electronic with Set and Resume Speed (requires available Driver Confidence and Cruise Package on LS)	○	●	●	●
– Adaptive Cruise Control ² (requires available Technology Package, Convenience Package and Driver Confidence Package)	-	-	○	○
Door locks – power programmable with lockout protection and manual rear door child security	●	●	●	●
Driver Information Center – 3.5-inch diagonal monochromatic display	●	●	●	●
– 4.2-inch diagonal multi-color display (requires available Convenience Package and Driver Confidence Package on LT; requires available Technology Package, Convenience Package and Driver Confidence Package on ACTIV and RS)	-	○	○	○
Floor mats – front and rear	●	●	●	●
Lighting – overhead courtesy, dual reading lamps, roof, rear courtesy and cargo area	●	●	●	●
Mirror – rearview, manual day/night	●	●	●	●
– rearview, auto-dimming (requires available Convenience Package and Driver Confidence Package)	-	○	○	○
Power outlet – 120-volt, on rear of center console (requires available Convenience Package and Driver Confidence Package)	-	○	○	○
Remote Keyless Entry – with panic alarm	●	●	●	●
– Keyless Open and Start, includes extended-range Remote Keyless Entry	-	●	●	●
Remote vehicle starter system	-	●	●	●

¹ Extra-cost color. ² Safety or driver assistance features are no substitute for the driver's responsibility to operate the vehicle in a safe manner. Read the vehicle Owner's Manual for important feature limitations and information.

● STANDARD ○ AVAILABLE – NOT AVAILABLE

	LS	LT	ACTIV	RS
INTERIOR (CONTINUED)				
Shift knob – Satin Silver and chrome	●	●	–	–
– leather-wrapped, Satin Silver and chrome	–	–	●	●
Steering column – manual tilt and telescopic	●	●	●	●
Steering wheel – 3-spoke with mounted audio, phone and Driver Information Center controls	●	●	●	●
– 3-spoke, leather-wrapped	–	–	●	–
– 3-spoke, Sport, leather-wrapped with contrasting stitching, Black bowtie emblem and flat-bottom design	–	–	–	●
– 3-spoke, heated (feature will not function on certain models without dealer retrofit; see dealer or window label for details)	–	–	○	○
Sunroof – panoramic power, dual-pane with power sunshade (requires available Convenience Package and Driver Confidence Package)	–	–	○	○
Visors – driver and front passenger, covered vanity mirrors	●	–	–	–
– driver and front passenger, covered vanity mirrors, sliding	–	●	●	●
– driver and front passenger, covered illuminated vanity mirrors, sliding (requires available Convenience Package and Driver Confidence Package on LT)	–	○	○	○
Windows – power with driver express-up/-down, all others express-down	●	●	●	●
SEATING				
Seats – front bucket	●	●	●	●
– rear manual-folding 40/60 split-bench	●	●	–	–
– rear manual-folding 40/60 split-bench with center armrest	–	–	●	●
Seat – driver 6-way manual adjuster	●	–	–	–
– driver 8-way power adjuster with 2-way power lumbar control	–	●	●	●
– front passenger flat-folding seatback	●	●	●	●
Heated driver and front passenger seats (feature will not function on certain models without dealer retrofit; see dealer or window label for details)	–	○	○	○

	LS	LT	ACTIV	RS
ENTERTAINMENT				
Chevrolet Infotainment 3 system ¹ with 7-inch diagonal color touch-screen, AM/FM stereo, Bluetooth [®] audio streaming ² for two active devices, voice command pass-through to compatible phone, and wireless Apple CarPlay ³ and wireless Android Auto ^{™4} compatibility	●	●	●	●
Chevrolet Infotainment 3 system ¹ with 8-inch diagonal color touch-screen, AM/FM stereo, Bluetooth audio streaming ² for two active devices, voice command pass-through to compatible phone, and wireless Apple CarPlay ³ and wireless Android Auto ⁴ compatibility (requires available Convenience Package and Driver Confidence Package)	–	○	○	○
Chevrolet Infotainment 3 Plus system ¹ with 8-inch diagonal HD color touch-screen, AM/FM stereo, Bluetooth audio streaming ² for two active devices, voice command pass-through to compatible phone, wireless Apple CarPlay ³ and wireless Android Auto ⁴ compatibility, available Alexa Built-in ⁵ , voice recognition, available In-Vehicle Apps ⁶ and Chevrolet Maps+ ⁷ (requires available Technology Package, Convenience Package and Driver Confidence Package)	–	–	○	○
Audio – 6-speaker system	●	●	●	●
– Bose premium 7-speaker audio system (requires available Technology Package, Convenience Package and Driver Confidence Package)	–	–	○	○
Media – USB ports ⁸ (one Type-A and one Type-C), 12-volt power outlet, and auxiliary input jack in front center stack storage area	●	●	●	●
– USB ports ⁸ (one Type-A and one Type-C), charge-only, on rear of center console (requires available Convenience Package and Driver Confidence Package)	–	○	○	○
HD Radio [®] (requires available Technology Package, Convenience Package and Driver Confidence Package)	–	–	○	○
SiriusXM ^{®9} – 3-month trial subscription to SXM Platinum Plan	●	●	●	●
SiriusXM with 360L ^{9,10} – 3-month trial subscription to SXM Platinum Plan (requires available Technology Package, Convenience Package and Driver Confidence Package)	–	–	○	○
Available Wi-Fi [®] Hotspot ¹¹ for up to seven devices, includes 1-month Unlimited Data Plan	○	○	○	○
Chevrolet Connected Access ¹² with up to 10 years of standard connectivity, which currently enables features such as Vehicle Diagnostics and Dealer Maintenance Notification	●	●	●	●
Wireless charging ¹³ (requires available Technology Package, Convenience Package and Driver Confidence Package)	–	–	○	○

¹ Chevrolet Infotainment System functionality varies by model. Full functionality requires compatible Bluetooth and smartphone, and USB connectivity for some devices. ² Go to my.chevrolet.com/learnAbout/bluetooth to find out which phones are compatible with the vehicle. Full Bluetooth feature functionality varies by device, model and software version. ³ Vehicle user interface is a product of Apple and its terms and privacy statements apply. Requires compatible iPhone and data plan rates apply. ⁴ Vehicle user interface is a product of Google and its terms and privacy statements apply. To use Android Auto on your car display, you'll need an Android phone running Android 6 or higher, an active data plan, and the Android Auto app. ⁵ Functionality is subject to limitations and varies by vehicle, infotainment system and location. Select service plan required. Certain Alexa Skills require account linking to use. Visit onstar.com for additional details. ⁶ Third-party trademarks are the property of their respective third-party owners and used under agreement. Requires active service plan and paid AT&T vehicle data plan. Visit onstar.com for details and limitations. ⁷ U.S. only. Requires select service plan. Functionality is subject to user terms and limitations and varies by vehicle model. Visit onstar.com for details and limitations. ⁸ Not compatible with all devices. ⁹ If you decide to continue service after your trial, your selected subscription plan will automatically renew thereafter. You will be charged at then-current rates. Fees and taxes apply. To cancel you must call SiriusXM at 1-866-635-2349. See SiriusXM Customer Agreement for complete terms at siriusxm.com. All fees and programming subject to change. ¹⁰ Certain features require a SiriusXM subscription and the Chevrolet Connected Access plan. See siriusxm.com and onstar.com for details and limitations. ¹¹ Service varies with conditions and location. Requires active service and paid AT&T data plan. Visit onstar.com for details and limitations. Availability subject to change. ¹² Standard connectivity available only to original purchaser for up to 10 years. Connected Access services are subject to change. Does not include emergency or security services. Diagnostic capabilities vary by model and service plan. Message and data rates may apply. Requires contact method on file and enrollment to receive alerts. Not all issues will deliver alerts. Visit onstar.com for details and limitations. ¹³ The system wirelessly charges one compatible mobile device. Some phones have built-in wireless charging technology and others require a special adaptor/back cover. To check for phone or other device compatibility, see my.chevrolet.com/learn or consult your carrier.

● STANDARD ○ AVAILABLE – NOT AVAILABLE

	LS	LT	ACTIV	RS
PACKAGES				
Driver Confidence and Cruise Package	○	–	–	–
Electronic cruise control with Set and Resume Speed, Lane Change Alert with Side Blind Zone Alert ¹ , Rear Cross Traffic Alert ¹ and Rear Park Assist ¹ (Rear Park Assist will not function on certain models without dealer retrofit; see dealer or window label for details)				
Convenience Package	–	○	○	○
Single-zone automatic climate control, Chevrolet Infotainment 3 system ² with 8-inch diagonal color touch-screen, 120-volt power outlet on rear of center console, charge-only USB ports ³ (one Type-A and one Type-C) on rear of center console, inside rearview auto-dimming mirror, and driver and front passenger illuminated vanity mirrors (requires available Driver Confidence Package)				
Driver Confidence Package	–	○	○	○
Lane Change Alert with Side Blind Zone Alert ¹ ; Rear Cross Traffic Alert ¹ and Rear Park Assist ¹ (Rear Park Assist will not function on certain models without dealer retrofit; see dealer or window label for details)				
Sun and Liftgate Package	–	–	○	○
Panoramic power dual-pane sunroof with power sunshade and hands-free programmable power liftgate with LED logo projection (requires available Convenience Package and Driver Confidence Package)				
Technology Package	–	–	○	○
Chevrolet Infotainment 3 Plus system ² with 8-inch diagonal HD color touch-screen, available Alexa Built-in ⁴ ; voice recognition, available In-Vehicle Apps ⁵ ; HD Radio ⁶ ; SiriusXM [®] with 360L ⁶ 3-month trial subscription to SXM Platinum Plan, Bose premium 7-speaker audio system, SD card reader in front center floor console storage area, wireless charging ⁷ , Adaptive Cruise Control ¹ , HD Rear Vision Camera ¹ , Driver Information Center with 4.2-inch diagonal multi-color display and LED headlamps (requires available Convenience Package and Driver Confidence Package)				

¹ Safety or driver assistance features are no substitute for the driver's responsibility to operate the vehicle in a safe manner. Read the vehicle Owner's Manual for important feature limitations and information. ² Chevrolet Infotainment System functionality varies by model. Full functionality requires compatible Bluetooth and smartphone, and USB connectivity for some devices. ³ Not compatible with all devices. ⁴ Functionality is subject to limitations and varies by vehicle, infotainment system and location. Select service plan required. Certain Alexa Skills require account linking to use. Visit onstar.com for additional details. ⁵ Third-party trademarks are the property of their respective third-party owners and used under agreement. Requires active service plan and paid AT&T vehicle data plan. Visit onstar.com for details and limitations. ⁶ If you decide to continue service after your trial, your selected subscription plan will automatically renew thereafter. You will be charged at then-current rates. Fees and taxes apply. To cancel you must call SiriusXM at 1-866-635-2349. See SiriusXM Customer Agreement for complete terms at siriusxm.com. All fees and programming subject to change. Certain features require a SiriusXM subscription and the Chevrolet Connected Access plan. See siriusxm.com and onstar.com for details and limitations. ⁷ The system wirelessly charges one compatible mobile device. Some phones have built-in wireless charging technology and others require a special adaptor/back cover. To check for phone or other device compatibility, see my.chevrolet.com/learn or consult your carrier.

MAXIMUM CAPACITIES

Fuel tank (approximate)	13.2 gallons
Passenger volume	98.2 cubic feet
Seating (front/rear)	Seats 2/3
Cargo volume ¹	Behind rear seats: 25.3 cubic feet With rear seats folded: 54.4 cubic feet

EPA-ESTIMATED FUEL ECONOMY

1.2L Turbo FWD	29 MPG city/31 highway/30 combined
1.3L Turbo FWD	29 MPG city/33 highway/31 combined
1.3L Turbo AWD	26 MPG city/30 highway/28 combined

DIMENSIONS

A - Wheelbase	103.9"
B - Length	173.5" - LS, LT 173.7" - ACTIV, RS
C - Height	65.2" - LS, LT, ACTIV FWD 65.3" - RS FWD 65.7" - LS, LT, ACTIV, RS AWD

D - Front track	60.9"
Rear track	61.3"
E - Width	71.2"

Head room (front/rear)	40.0"/38.4"
Head room with sunroof (front/rear)	38.3"/36.8"
Leg room (front/rear)	40.9"/39.4"
Shoulder room (front/rear)	55.4"/53.8"
Hip room (front/rear)	52.3"/45.7"

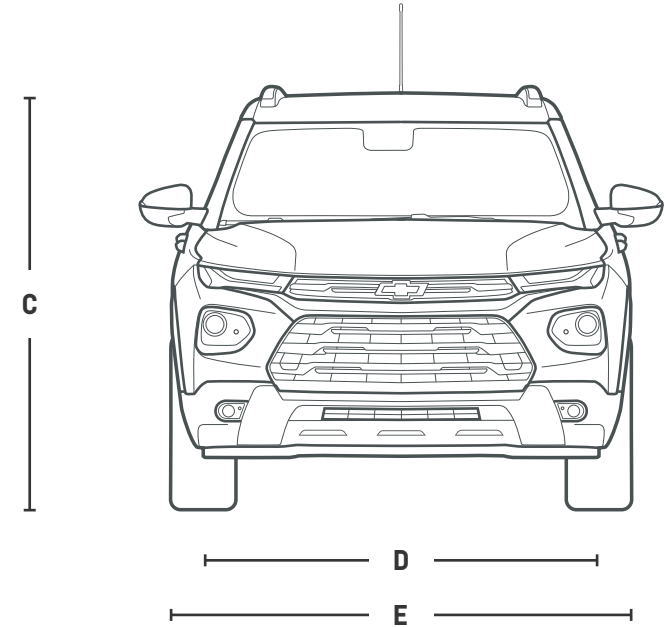
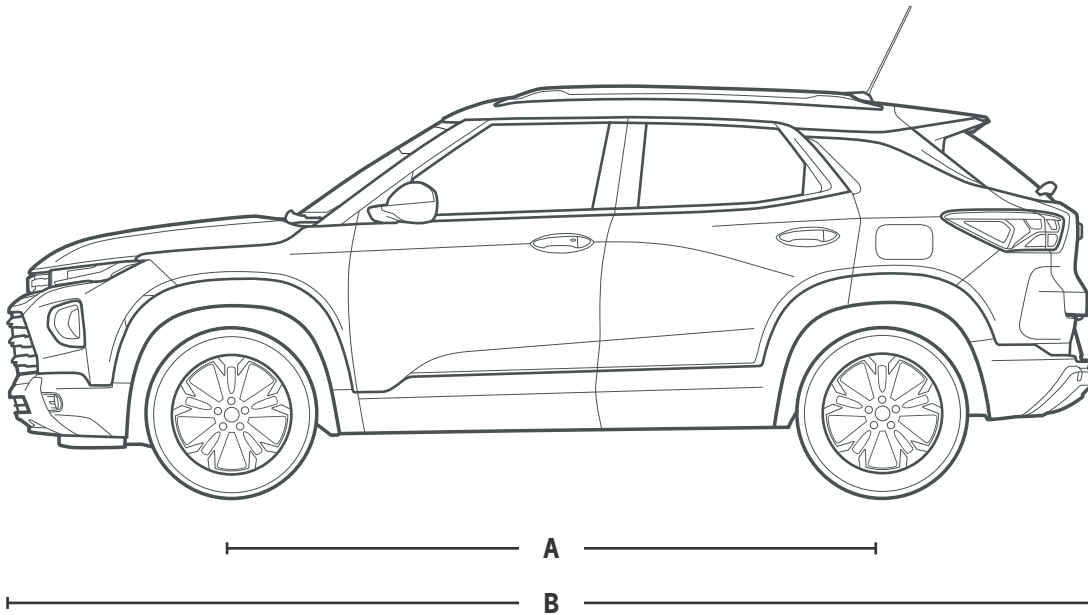

¹ Cargo and load capacity limited by weight and distribution.



Splash Guards available from Chevrolet Accessories.



All-Weather Cargo Mat available from Chevrolet Accessories.



All-Weather Floor Liners available from Chevrolet Accessories.



Bowtie Emblem in Black available from Chevrolet Accessories.



Important information.

You may be discovering Chevrolet through a personalized online shopping experience or enjoying every year of vehicle ownership. Either way, we're committed to providing the tools and programs you need to help you get the most out of your journey.

Build & Price >

Create your perfect Chevrolet from start to finish.

Chevy MyWay¹ >

Engage in a real-time virtual video experience with a Chevy product specialist.

Chevrolet Complete Care >

Enjoy an owner benefit program that provides excellent service and support from day one.

My Chevrolet Rewards² >

Unlock a world of appreciation that's all about you and your Chevrolet. Start earning and redeeming today.

Limited Warranty Coverage >

Discover all the ways Chevrolet is committed to providing an excellent ownership experience.



GM, the GM logo, Chevrolet, the Chevrolet logo, and the slogans, emblems, vehicle model names, vehicle body designs and other marks appearing in this brochure are the trademarks and/or service marks of General Motors, its subsidiaries, affiliates or licensors. ©2022 OnStar LLC. All rights reserved. Sirius, XM, SiriusXM and all related marks and logos are trademarks of Sirius XM Radio Inc. Amazon, Alexa and all related marks are trademarks of Amazon.com, Inc. or its affiliates. The Bluetooth word mark is a registered trademark owned by Bluetooth SIG, Inc., and any use of such mark by Chevrolet is under license. Bose is a registered trademark of the Bose Corp.

©2022 General Motors. All rights reserved. September 2022

FIND NEW ROADS™

CHEVROLET.COM

¹ Chevy MyWay is available to anyone over 18 in the United States to access and experience via chevrolet.com/myway. ² Must be 18 years or older. Points may be earned and redeemed only at GM entities, My Chevrolet Rewards participating dealers or third party retailers in the United States (excluding Puerto Rico, the U.S. Virgin Islands or Guam). Points are not earned on taxes, fees or body shop repair orders and expire without further notice upon Member Account deactivation. Visit myChevroletrewards.com to view My GM Rewards Terms & Conditions.